



High-frequency transformer

EE25 Series

Parameters/Dimensions:

EE25 Type 1

Information:

Shape:EE25

1 Power:30W

2 Mounting Orientation: Vertical

3 Size: 27 (W) * 21 (L) * 23 (H)

4 Effective Ae (mm²): 39.77

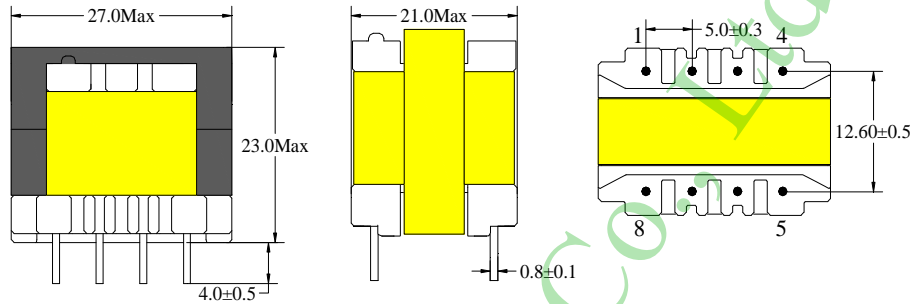

EE25 Type 2

Information:

Shape:EE25

1 Power:30W

2 Mounting Orientation: Vertical

3 Size: 28(W) * 22(L) * 22(H)

4 Effective Ae (mm²): 39.77

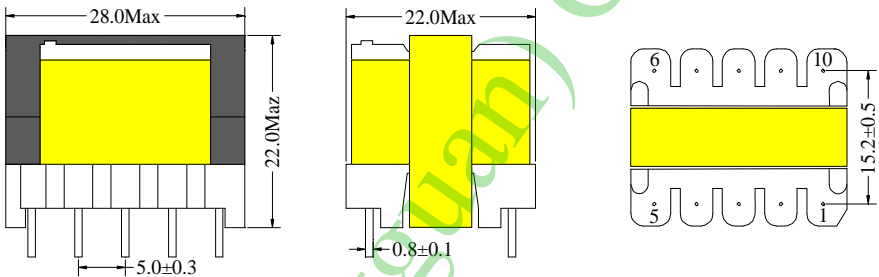

EE25 Type 3

Information:

Shape:EE25

1 Power:30W

2 Mounting Orientation: Vertical

3 Size: 27 (W) * 19 (L) * 27 (H)

4 Effective Ae (mm²): 39.77

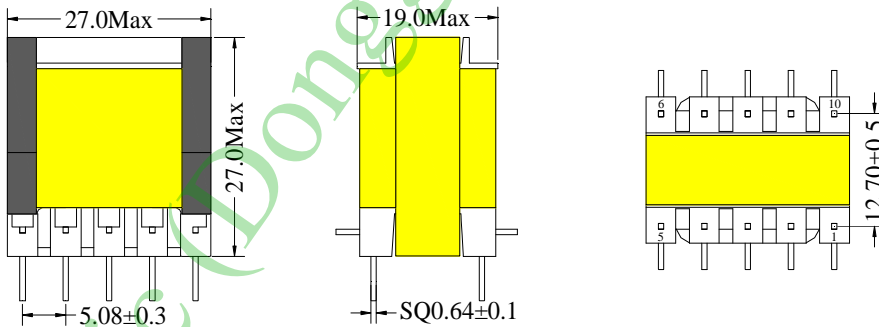

EE25 Type 4

Information:

Shape:EE25

1 Power:30W

2 Mounting Orientation: Vertical

3 Size: 33(W) * 23(L) * 20(H)

4 Effective Ae (mm²): 39.77

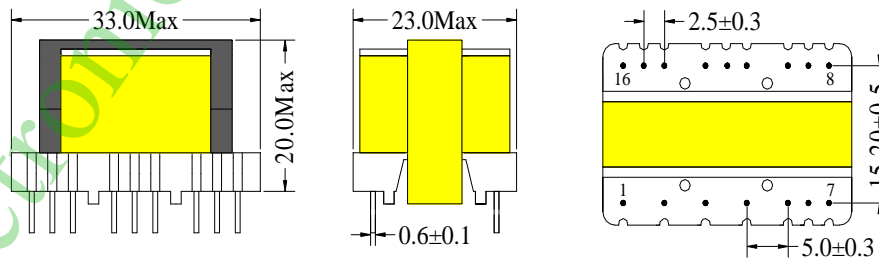

EE25 Type5

Information:

Shape:EE25

1 Power:30W

2 Mounting Orientation: Vertical

3 Size: 30 (W) * 23 (L) * 36 (H)

4 Effective Ae (mm²): 39.77

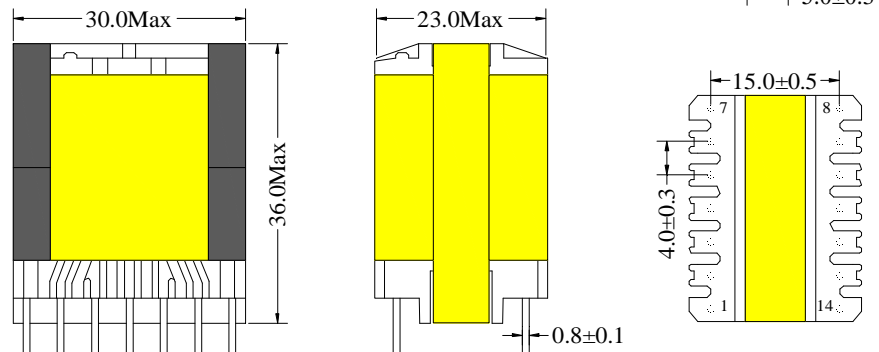

EE25 Type 6

Information:

Shape:EE25

1 Power:30W

2 Mounting Orientation: Vertical

3 Size: 27 (W) * 20.5 (L) * 18 (H)

4 Effective Ae (mm²): 39.77

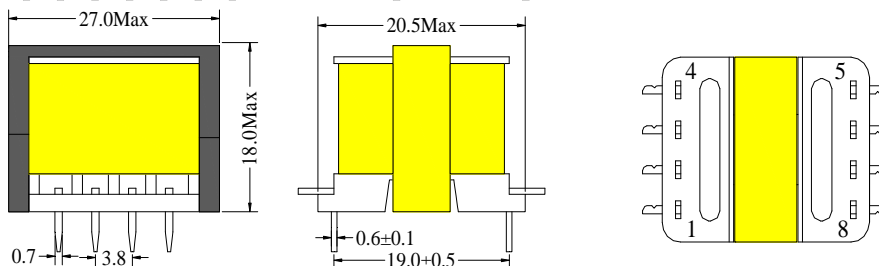



High-frequency transformer

EE25 Series

Parameters/Dimensions:

EE25 Type 7

Information:

Shape:EE25

1 Power:30W

2 Mounting Orientation:Horizonta

3 Size: 27 (W) *20.5 (L) * 18 (H)

4 Effective Ae (mm2): 39.77

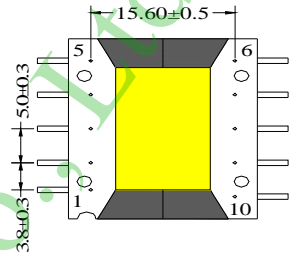
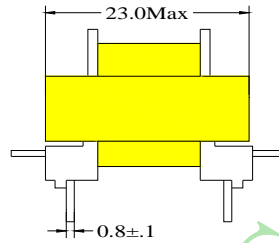
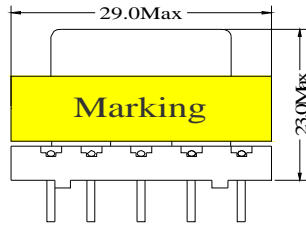

EE25 Type 8

Information:

Shape:EE25

1 Power:30W

2 Mounting Orientation:Horizonta

3 Size: 27 (W) *20.5 (L) * 18 (H)

4 Effective Ae (mm2): 39.77

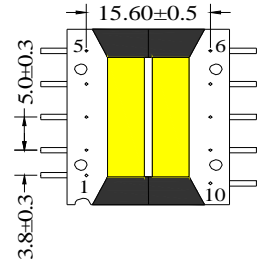
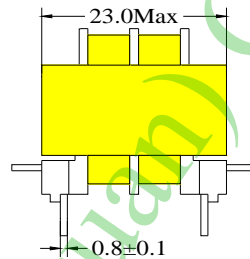
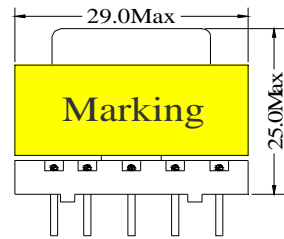

EE25 Type 9

Information:

Shape:EE25

1 Power:30W

2 Mounting Orientation:Horizonta

3 Size: 29 (W) *22 (L) *26 (H)

4 Effective Ae (mm2): 39.77

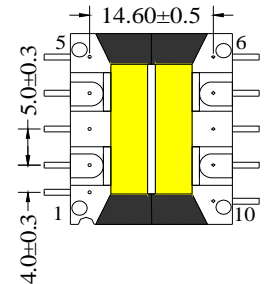
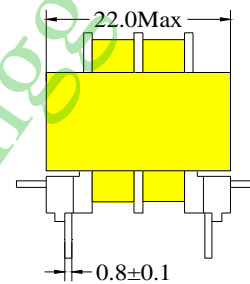
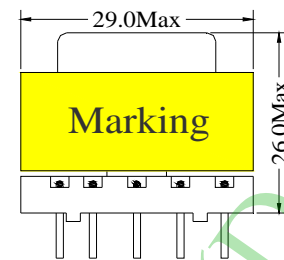

EE25 Type 10

Information:

Shape:EE25

1 Power:30W

2 Mounting Orientation:Horizonta

3 Size: 28 (W) *20 (L) *23 (H)

4 Effective Ae (mm2): 39.77

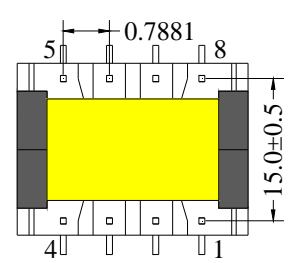
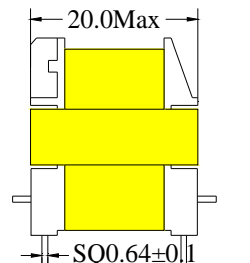
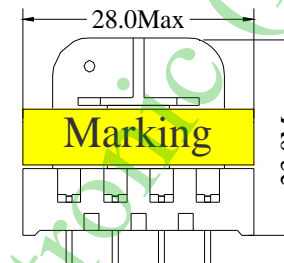

EE25 Type 11

Information:

Shape:EE25

1 Power:30W

2 Mounting Orientation:Horizonta

3 Size: 28(W) *36 (L) *21(H)

4 Effective Ae (mm2): 39.77

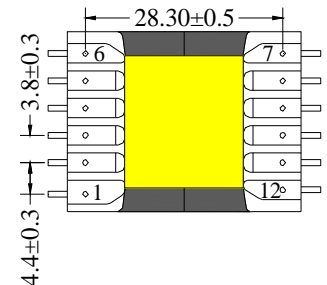
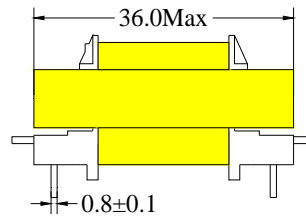
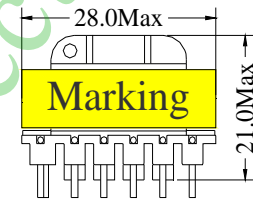

Note:

Bobbin type listed in the traditional style, transformer design parameters to customer needs or to inject prevail.

EE series high-frequency transformer features:

Lead space, easy winding wire. Applicable to a wide range of high frequency, wide operating voltage range, output power, good thermal stability

Uses:

Program-controlled switches are widely used in power supplies, LCD power supply, UPS power inverter power supply, computer power, energy-saving lamps and other fields.